

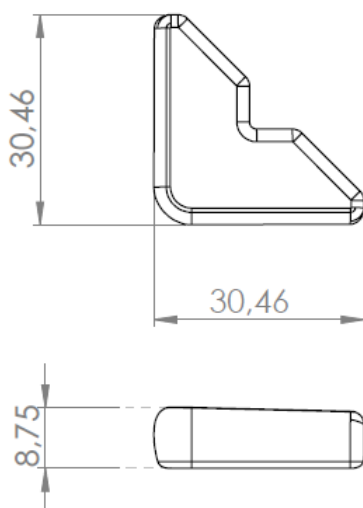

PAPROTECH

PLASTIC PRODUCTS

Specyfikacja techniczna: narożnik 30B

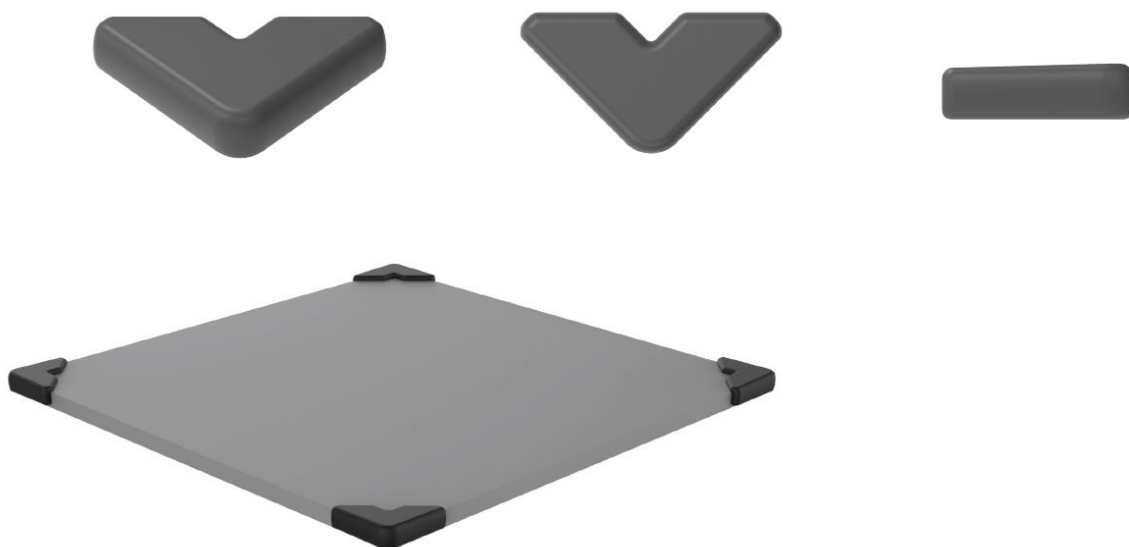

PAPROTECH
ul. Ślusarska 7, 20-209 Lublin
tel.: 601 48 08 24; 81 440 34 62, fax.: 81 440 34 82
e-mail: piotr@paprotech.pl , www.paprotech.pl
NIP 737-184-41-15